

**Titan**

**Titan-Lucas  
Massage Chair**

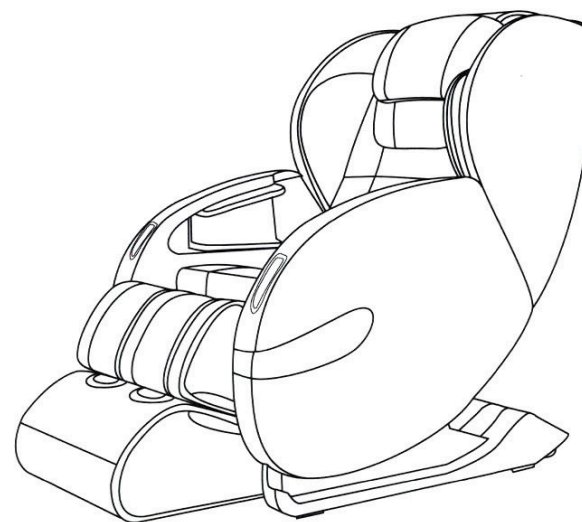

**User Handbook**

# CONTENTS

Please read and follow all safety and operating instructions listed in this user manual prior to use. Basic precautions should always be used when operating an electrical appliance.

Safety Instructions	-----2
Product Specifications	-----4
Product Components	-----5
Chair Installation	-----7
Before Use	-----9
Remote Controller	-----10
Operation Guide	-----11
Troubleshooting	-----15
Maintenance	-----16

## SAFETY INSTRUCTION

### Warning

The power plug must be inserted properly to the outlet. If the connection of the Equipment-grounding conductor is not connected properly it can result in the risk of electric shock. Check with a qualified electrician or service technician, if you are in doubt as to whether the product is properly grounded. Do not modify the plug provided with the product, if the outlet is not suitable. Please make sure that the outlet is properly installed by a qualified electrician. When using the massage chair, basic precautions should always be followed to reduce the risk of electric shock, burns, fire or injury.

1. Please make sure that the power plug of massage chair is properly inserted in a proper electrical outlet.
2. Make sure the power plug is properly inserted into the proper electrical outlet to reduce the risk of short-circuit and fire.
3. Always unplug the massage chair from the electrical outlet immediately after use and before cleaning.
4. Do not use the massage chair in places where the humidity is high.
5. Do not use the massage chair outdoors and avoid place with direct sunlight.
6. If the power turns off during using make sure to switch the power OFF position and pull the power plug out from the socket to prevent damage from occurring when the power is restored.
7. Do not operate the massage chair if the power cord is wet or damaged.
8. Do not plug/unplug the power cord from the socket with wet hands.
9. Supervision is necessary when the massage chair is being used by on or near the children or disabled persons.
10. Use the massage chair only for its intended use as described in this user manual.
11. Do not stand, sit or jump in the calves rest, backrest and armrest when the massage chair is in use to prevent any injury.
12. Do not fall asleep during the massage session.
13. Always keep the massage chair clean and do not insert any object into the gaps and around the massage chair.
14. Do not move the massage chair by pulling the power supply cord.
15. Make sure that there are no person (children in particular) pet or obstacles underneath the massage chair prior to lowering the leg rest/backrest.

## SAFETY INSTRUCTION

16. Always check the surface of the massage chair is torn or ripped before usage, if you find any unfamiliar rips in any area of the cloth in the backrest, do not use the massage chair. Kindly contact the service center for repair.
17. This appliance is designed for household use only.
18. For those suffering from illnesses, please consult your doctor for advice prior to use.
19. The following conditions should consult doctor's before use:
  - (a) Suffering malignant tumor
  - (b) People with heart disease
  - (c) Women in pregnancy, menstruation and puerperal fever
  - (d) People who are medicated or under medication
  - (e) People with osteoporosis
  - (f) People with back bended exceptionally by the accident or disease
20. If you experience pain during usage, stop using the massage chair immediately. If any injuries occur, seek medical treatment immediately.
21. Do not massage the swollen or inflamed parts of the body.
22. This product is non-professional appliance designed to provide a comfortable massage. Do not use this product as substitute for medical treatment.
23. Each massage session should not exceed 30 minutes. Massage the targeted area only for 15 minutes, over massaging can lead to overheating, thus giving the appliance a shorter lifespan.
24. Do not operate where aerosol (spray) products are used or where oxygen is being administered.
25. The massage chair is not suitable for children aged 12 and below.
26. Please make sure that the massage chair is placed on a flat level ground.

### NOTE:

This appliance is not intended to use by persons (including children) to reduced physical sensory or mental capabilities or lack of experience and knowledge, unless they have been given supervision or instruction concerning to use this appliance by a responsible person for their safety.

Children should be supervised to make sure that they do not play the appliance.

If the supply cord is damaged it must be replaced by a special cord or assembled available from the manufacturer or its service agent.

This appliance heats up during operation, person's sensitive to heat must take extra caution when using the appliance.

## PRODUCT SPECIFICATIONS

Description	Specifications
Product Name	Massage chair
Model No.	Lucas
Rated Voltage	110-120V~
Rated Frequency	50/60Hz
Rated Power Consumption	230W Max.
Dimension (LxWxH)	1515mmx810mmx1210mm
Weight	Net Weight: 94kg    Gross Weight: 113kg

## PRODUCT COMPONENTS

Main Body Diagram (Front)

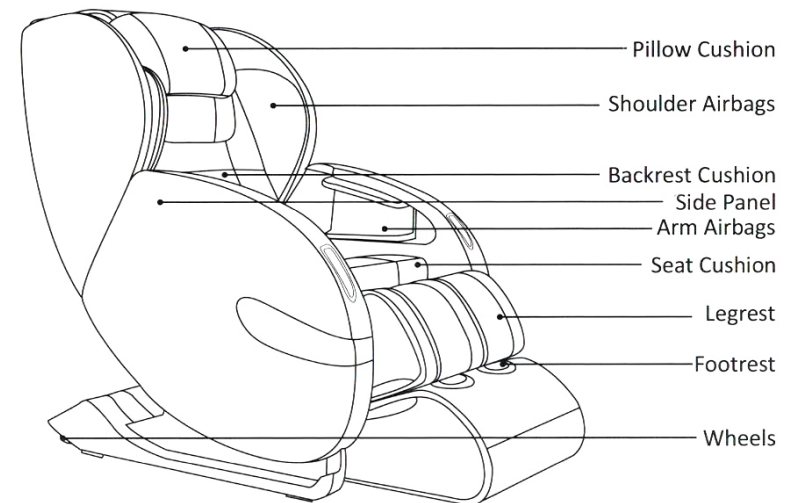

## PRODUCT COMPONENTS

Main Body Diagram (Rear)

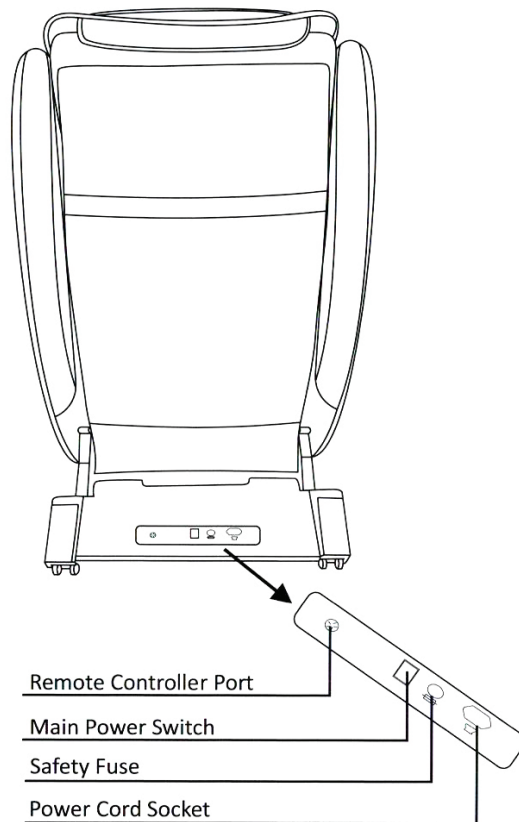

## CHAIR INSTALLATION

### 1. Remove the package and get out the spare parts

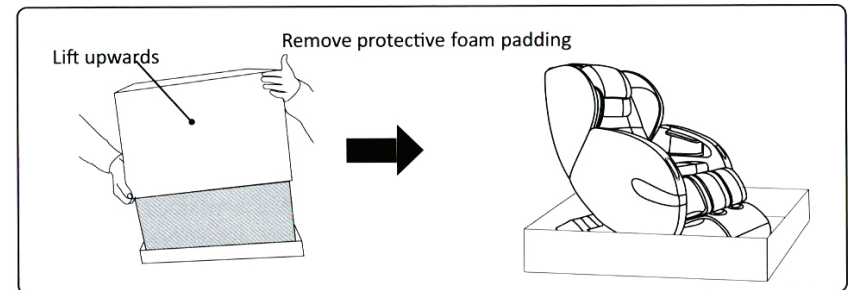

- 1) Remove the carton.
- 2) Take out the foam.
- 3) The spare parts include: remote control, user manual, power cord.

### 2. Place the massage chair in an open area

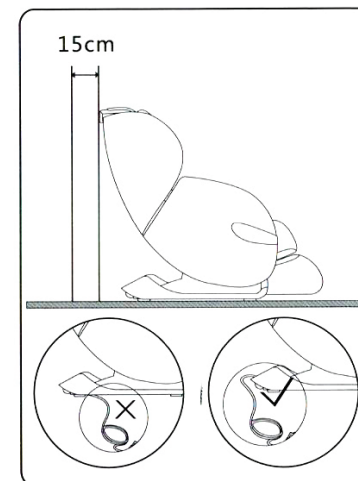

- Allow sufficient space around the chair for recline purposes.  
15cm distance for the back side and 50cm in front of the footrest.
- \*In order to avoid the damage of the floor and to reduce the noise, please put area rug under the massage chair.**
- \*Make sure that there are no barriers in front and the back of the massage chair.**
- \*Please do not put it in wet or uneven floor.**
- \*To avoid signal interference, please place it 4 feet away from AV,TV, and radio.**

## CHAIR INSTALLATION

**3. Double check installation steps, smooth out any creases in the cushions**

**4. Moving the massage chair**

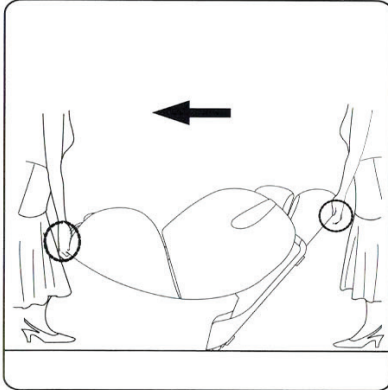

1. As illustrated, push the backrest downwards and tilt chair on to its wheels at a 45° angle. Slowly push and maneuver the massage chair to desired location. Lower massage chair slowly and smoothly until it is fully flat on the ground.

- \* Do not move massage chair when occupied or in use.
- \* Moving the massage chair may cause damage to floors. Floor protection is recommended (e.g. rugs, carpet).
- \* Do not drop or suddenly let go of the chair when moving as it may damage the chair.
- \* Two person participation is recommended. Please use extra care when handling the massage chair.

## BEFORE USE

**1. Make sure that the product is good.**

- Confirm that headrest and backrest pad are normal
- Confirm that the power plug is normal.
- Make sure whether the footrest is erect. (if it is under the horizontal surface, when you sit on the chair and exert big force the chair will be damaged)

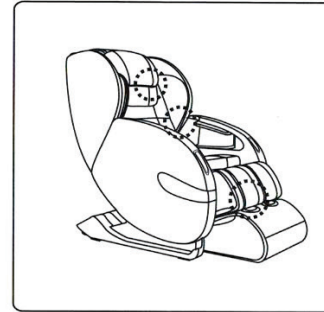

**2. Confirm the surrounding environment**

- Make sure whether there are no barriers around the massage chair

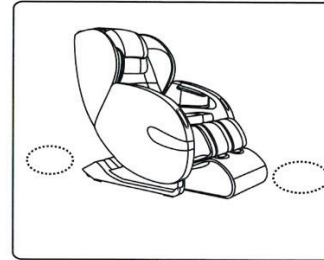

**3. Connect the power of the chair**

- Connect the power line
- Turn on the power switch on the right side of the chair

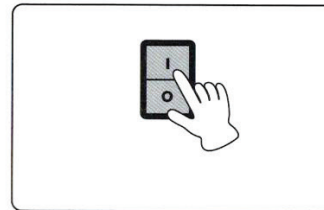

**4. Adjusting the position of the headrest when using**

- Adjust the under-part position of the headrest and make the position of the ear and it on the same horizontal plane.

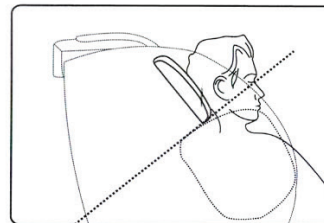

REMOTE CONTROLLER

1 Remote Controller

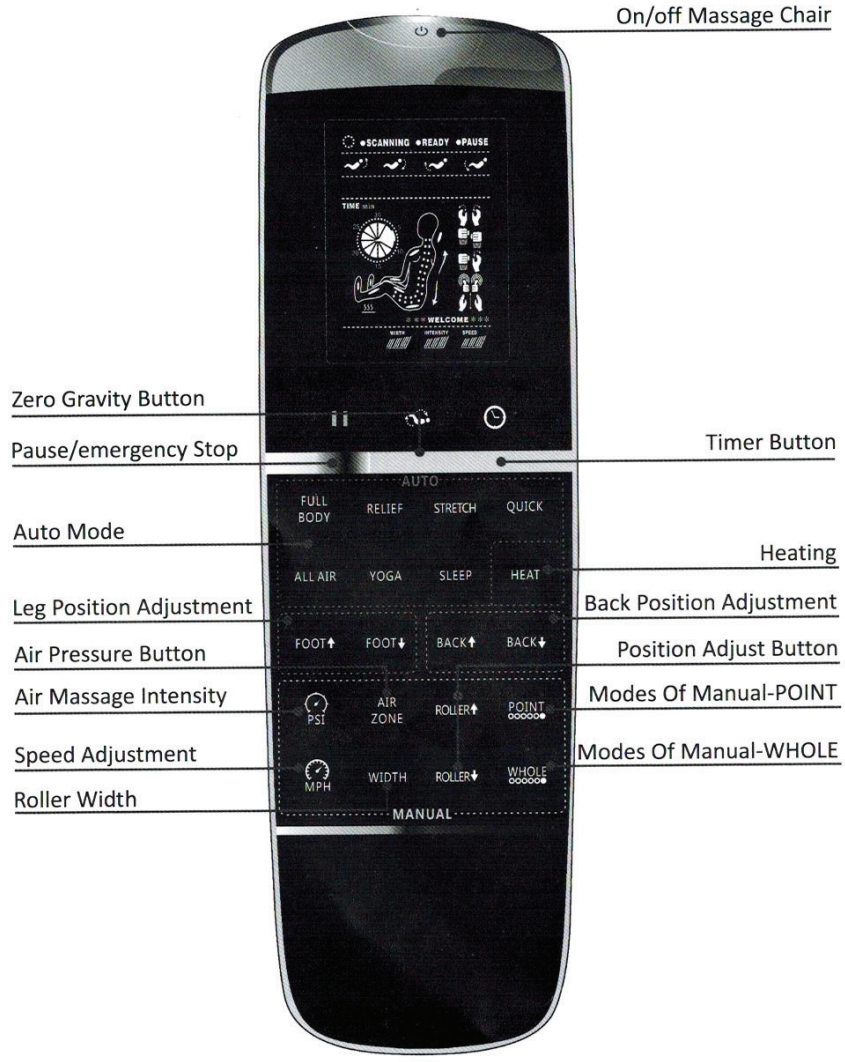

2 Function description of Controller buttons.

 : Press once to power on the massage chair, press again to power off.

 : Press to temporarily pause the massage, chair will enter idle mode. Press again to resume massage.

 Timer Button: The massage chair is preprogrammed at an optimal 15 minute time period. Press once to increase by 5 minutes in the following sequence: 15 -> 20 -> 25 -> 30 -> 5 -> 10 -> 15.

Position adjustment area:

 : Press the button first, massage back and leg position to zero G1, press second, the position to zero G2, press third, the position to zero G3, press fourth, massage chair return to original position.

Zero G1 -> Zero G2 -> Zero G3 -> Original Position.

 : Press the button and hold on to adjust the massaging position of backrest or legrest.

 : Press the button and hold on to adjust the footrest independently.

Auto mode:

 This chair design with 7 sets of auto massage program for different time and people to use.  
 FULL BODY - RELIEF - STRETCH - QUICK  
 FULL AIR - YOGA - SLEEP

- When you use it continuously, Please have 10 minutes of rest in order not to add burden to the body.

## OPERATION GUIDE

### Manual mode



Modes Of Manual-POINT: This button allow you to choose the most desirable personal massage program such as Kneading Point -> Tapping Point -> Dual Point -> Shiatsu Point -> Massage Point -> Off.



Modes Of Manual-WHOLE: This button allow you to choose the most desirable personal massage program such as Kneading Whole -> Tapping Whole -> Dual Whole -> Shiatsu Whole -> Massage Whole -> Off.



Speed: Tapping & Kneading & Dual Action & Shiatsu & foot Roller & Calf Kneading Speed adjustment (3 levels)



Press this button to adjust the width of 2 roller, Three levels is adjustable.



Roller Location Adjustment: Hold the up or down arrow to move the massage rollers to the desired location.



Pressure massage position button. Each time you press this button, there will be a spot flashing in screen, which means that part will be massaged. Press the button continued, there will be different parts of the combination of massage.



This button allows you to control the intensity of the air bag on 3 different intensity levels.



Switch on/off for back heating function.

## OPERATION GUIDE

### 3 Display Diagram

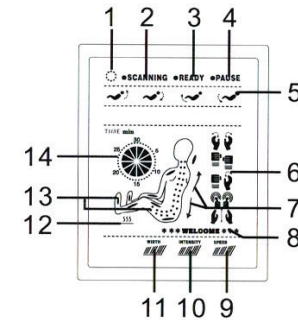

1. Massage chair is powered on.
2. Massage chair is scanning the back contour and preparing for initiation.
3. Scanning is complete and ready for massage programs.
4. Pause button has been pressed and chair is temporarily stopped.
5. Reclining position adjustment buttons are pressed and the backrest and /or legrest are moving.
6. Displays which massage technique is activated at the time.
7. Depicts the direction of the massage rollers, moving upwards or downwards.
8. Cheerful greeting from your massage chair.
9. Shows the massage speed level.
10. Shows the air intensity level.
11. Shows massage roller width.
12. Heating function is on.
13. Displays the location of massage rollers and active air bags.
14. Depicts time remaining in current massage program.



## OPERATION GUIDE

### 4 The method of playing the bluetooth music in massage chair :

A: Match: Open the bluetooth function in mobile phone or Ipad ,and search nearby. Choose the massage chair bluetooth music equipment and match with it, the pass word is 0000(or1234). (Note: The massage chair Blue tooth code H163)

B: Play music:After matching with it, you can display the music by mobile or APP music display software.

### 5 After use

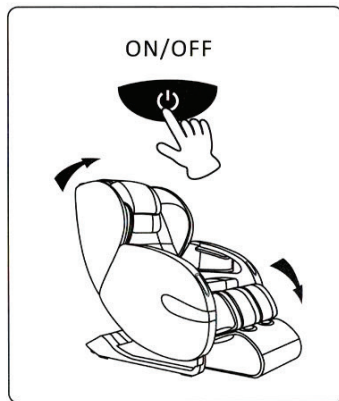

1. After the massage program is completed, please press the switch button,the massage chair will be automatically recover.
- Please check surrounding area prior to adjust the recline angle, pay special attention to children or pets that may be close proximity.
- Please make sure your arms and legs are away from gaps between the armrest, legrest, and footrest, to prevent any possible pinching or injury.
2. Press the power button to power off the massage chair and return remote controller to the storage box.
3. Turn off the main power switch.
4. Remove plug from power outlet.
  - \* Please do not pull on the power cord to remove the plug.
  - \* Please do not unplug with wet hands.

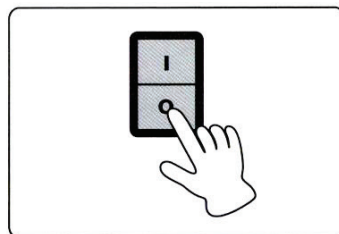

## TROUBLE SHOOTING

If the sounds or movements are not normal, please turn off the massage chair and remove the plug from the electric outlet. Please contact the customer service department for further assistance.

Problem	Solution
The massage chair is connected to power but is not functioning.	<ol style="list-style-type: none"> <li>1. Check to see if the power plug is inserted properly or if the power outlet is functioning properly.</li> <li>2. Check to see if the main power switch is in the "I" position.</li> </ol>
The remote controller is responding, but the massage chair is not functioning.	The massage chair may have automatically shut down due to overheating protection devices. Please turn off the power and allow the chair to cool off for 30-50 minutes.
Both the remote controller and massage chair are not responding.	The massage chair automatically turns into "full stop" or into "idle" mode when a massage program is completed. Please press the power button again to turn on the chair.

## MAINTENANCE

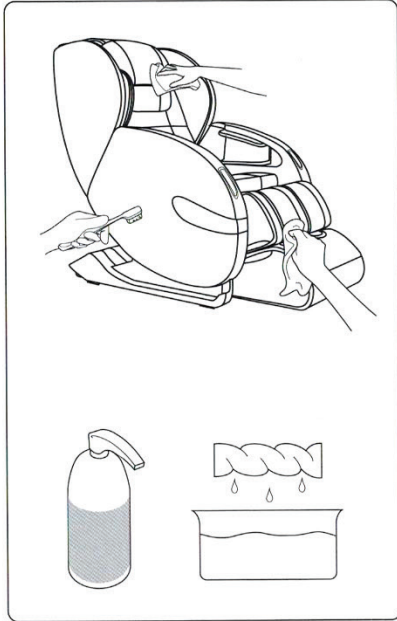

- Use dry cloth to wipe sweat and other besmirch.

- Besmirch is serious, please use neutral wash to wipe and lightly brush the massage chair.

- Please airing.

- Turn off and pull out the plug before clean the massage chair, do not touch the plug with wet hands.

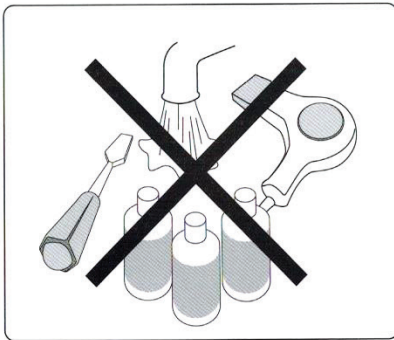

- Prohibit to use water to clean the chair.

- Do not dry the chair with roaster.

- Prohit to use alcohol, benzene wash etc.